

*Print Shop*



# 1962 TOY AND HOBBY LINE

AMERICAN TOY & FURNITURE CO. Inc.  
6130 N. Clark St. Chicago 26, Ill.



"Teach 'N Fun"

# WOODBURNING SETS

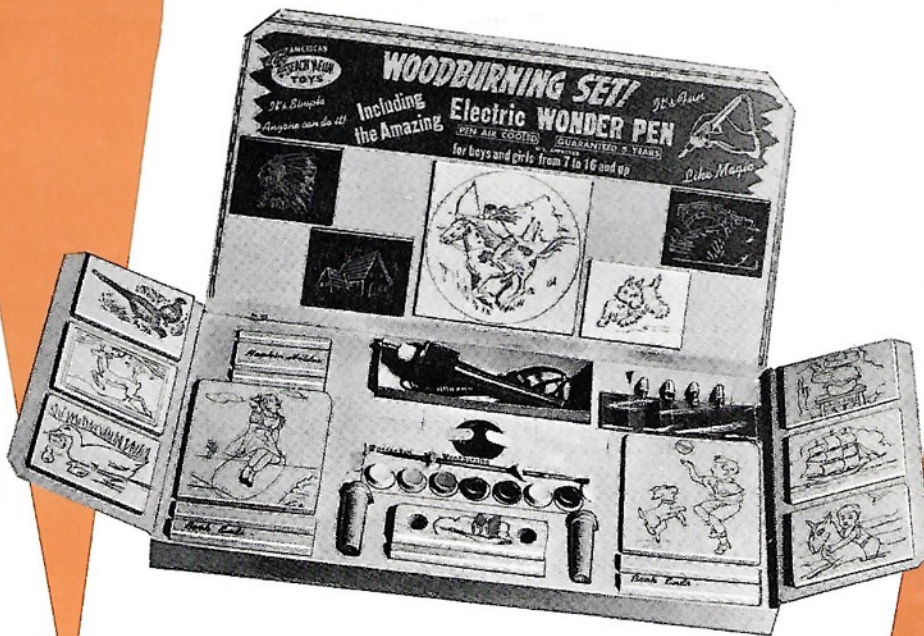
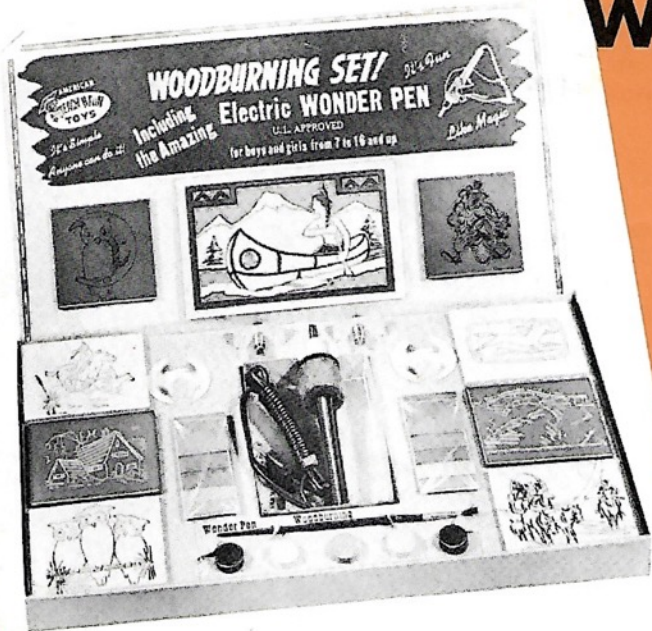

## No. 93—WONDER PEN WOODBURNING SET

(Size: 16½" x 9" x 1½"—closed)

Woodburning as a hobby has delighted boys and girls through the years. This introductory set includes, in addition to the guaranteed Electric Wonder Pen, 9 fascinating plaques, 6 color chips, paint brush, 2 paint dishes, color foil, 2 extra brass points and a manual of instruction. Packed 1 dozen to shipping carton; wt. 17½ lbs. **\$3.00**

## No. 2500—ECONOMY WOODBURNING SET

(Size: 16" x 7" x 1½")

Includes Wonder Pen, 6 plaques, 6 paint chips, paint dish, brush and instructions. Packed 1 dozen to shipping carton; wt. 13 lbs. **\$2.50**

## No. 95—WONDER PEN WOODBURNING SET

(Size: 20" x 11" x 1¾"—closed)

A wonderland of exciting fun! Set contains a complete assortment of plaques, plus pre-cut book-ends and salt and pepper shakers—a total of 19 pieces for burning. Also included are: Wonder Pen with 4 additional points, 7 paint chips, paint dish, brush, color foil, plus woodburning booklet. Packed ½ dozen to shipping carton; weight 16½ lbs. **\$5.00**

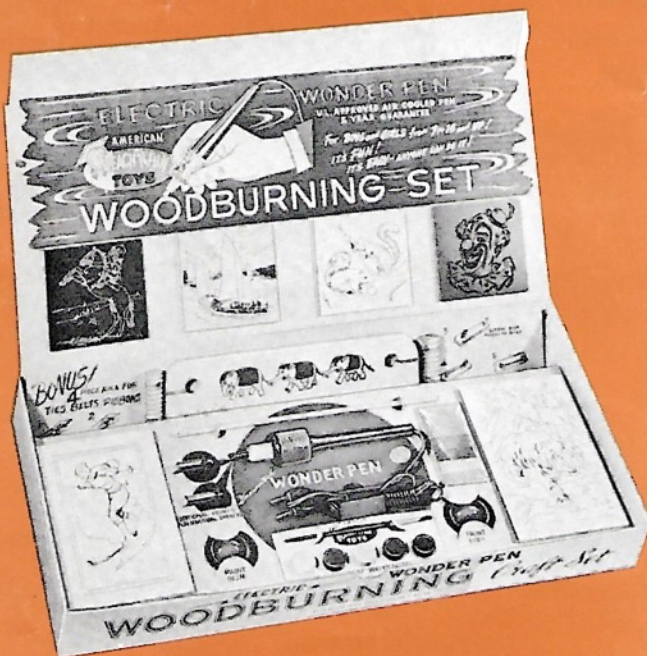

## No. 693—KING-SIZE WOODBURNING SET

(Size: 20¼" x 9½" x 2¾"—closed)

A colorful, eye-catcher which includes the guaranteed Wonder Pen, 2 additional points, 2 paint dishes, 6 distinctive plaques—plus a 4-piece Bonus Project—rack for ties, belts, ribbons. Also contains color foil, palette with paint chips and brush. Packed 1 dozen to carton; 21 lbs. **\$3.00**

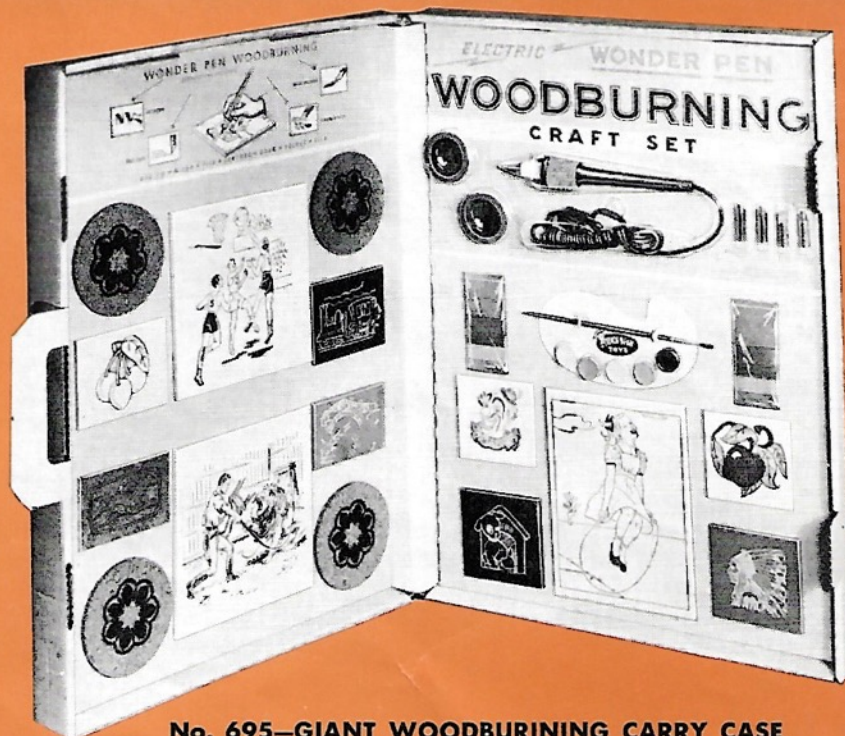

## No. 695—GIANT WOODBURNING CARRY CASE

(Size: 20¼" x 14¾" x 4¼"—closed)

A proven set for point of sale impact! Includes 15 assorted action plaques, 5 paint chips with brush, and 2 foil packages, as well as the famous guaranteed Wonder Pen with 4 additional points. Interior completely plastic encased for clear display and full protection. Packed ½ dozen to carton; 19 lbs. **\$5.00**

# Electric WONDER PEN—guaranteed 5 years!



**No. 97—DELUXE WONDER PEN WOODBURNING SET**  
(Size: 20" x 11" x 2" — closed)

Hours of creative pleasure await the happy child who owns this all-inclusive kit. Set includes 16 assorted plaques, plus 2 fascinating projects—a 3-piece salt and pepper shaker set with 3-piece desk set—guaranteed Wonder Pen with four additional points, color foil, 7 paint chips with brush, 2 paint dishes and woodburning manual. Packed 3 to carton; shipping wt. 10 lbs. **\$7.00**

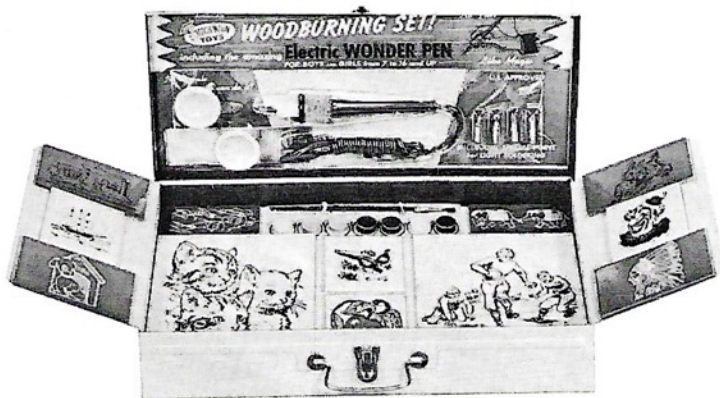

**No. 96—MASTER WOODBURNING CHEST**  
(Size: 16" x 8" x 3" — closed)

A complete, portable woodburning workshop! Full color steel storage chest with metal carrying handle. The Wonder Pen and 4 additional points are encased in a protective plastic shell. Set includes 12 beautiful plaques, 7 color chips, brush, 2 paint dishes, color foil and manual. Packed 1/2 dozen to carton. Shipping weight 24 lbs. **\$5.00**

**No. 90—WOODBURNING WINDOW PACKAGE**  
(Size: 18 1/2" x 10 1/2" x 1 3/8")

This marvelous beginner's woodburning set is designed especially for children to develop their artistic talents. Complete with UL approved Wonder Pen, 9 attractive plaques, 5 color chips, brush, paint dish and easy-to-follow instructions. Packed 1 dozen to a carton. Shipping weight 17 lbs. **\$3.00**

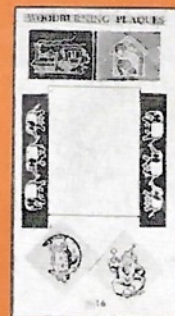
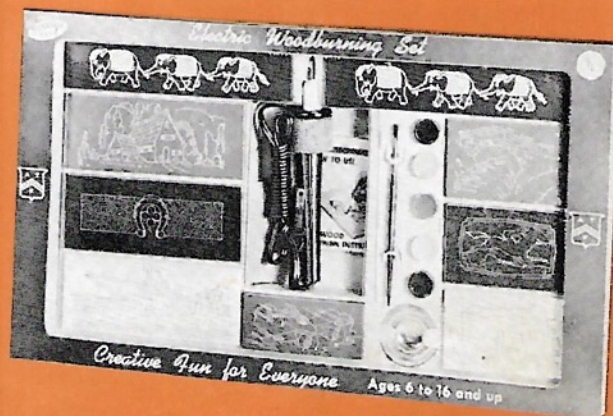

**No. 16—WOOD PLAQUE ASSORTMENT—7 pieces**  
Beautiful woodburning plaques printed with exciting designs in sizes ranging up to 7" x 5" as shown above. Skin-carded for maximum display and protection at point of sale. Packed 2 doz. to carton; shipping wt. 22 lbs. **\$1.00**

**No. 17—LARGE PLAQUE ASSORTMENT—9 pieces**  
Beautiful scenes and pictures to be burned in wood—plus a 3-piece Salt and Pepper Shaker Project for burning. Includes 6 plaques up to size 10" x 7" as shown above. All items skin-carded for maximum display and protection at point of sale. Packed 2 doz.; shpg. wt. 26 lbs. **\$2.00**



**No. 15—PROFESSIONAL 9 POINT WONDER PEN SET**

A professional set for obtaining amazing effects on wood, leather, etc. The guaranteed UL approved Wonder Pen can be used for light soldering as well! The attractive window box includes the Wonder Pen and 8 additional points, each producing a distinctive effect, foil and manual. Packed 2 dozen to a carton. Shipping wt. 14 lbs. **\$3.00**



# AMERICAN



**No. M2—AMERICAN TOOL CHEST—Ages 3-6**

This beginner's set in all-steel carrying kit, includes 10 pieces—color-tipped hammer, steel hand saw, pliers, screw driver, plus triangle, ruler, etc. Size 12 $\frac{1}{4}$ " x 5" x 2 $\frac{1}{8}$ ". Packed 1 doz. Shipping wt. 25 lbs. **\$2.00**



**No. M3—AMERICAN TOOL CHEST—Ages 3-9**

Ideal set for the young handyman. 14 pieces include tempered spring steel saw, pliers, square, screw driver, hammer, wrench, etc. In sturdy steel chest. Size: 14 $\frac{1}{8}$ " x 5" x 2 $\frac{1}{2}$ ". Packed 1 doz. Shipping wt. 34 lbs. **\$3.00**

**No. M4—AMERICAN TOOL CHEST (Not Illustrated)**

A 17 piece set which includes in addition to above mentioned, a larger hammer, plane and punch. Packed 1 doz. Weight 40 lbs. **\$4.00**

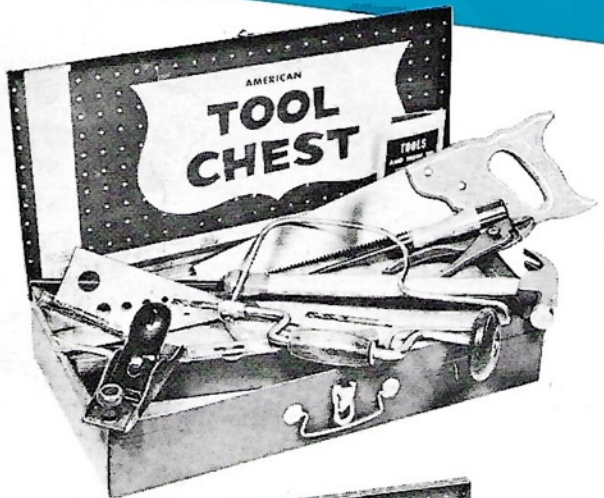

**No. M6—AMERICAN TOOL CHEST—Ages 4-9**

Young handyman's constant companion—this sturdy 20 piece tool chest includes brace, assorted drill bits, large tempered spring steel hand saw, 12" hammer, coping saw, pliers, level, cast iron plane, steel square, screw driver, etc. Size 16 $\frac{1}{8}$ " x 8" x 3 $\frac{1}{8}$ ". Packed  $\frac{1}{2}$  doz. Shipping wt. 33 lbs. **\$5.00**

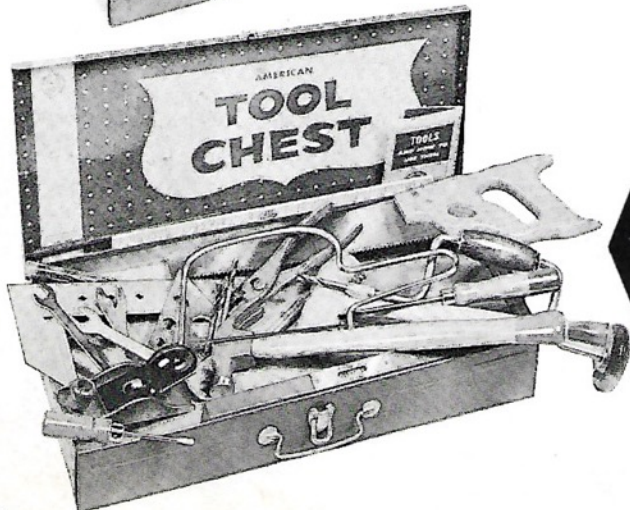

**No. M7—AMERICAN TOOL CHEST—Ages 4-12**

Fully-equipped 29 piece tool chest! Includes brace, assorted bits, tempered spring steel hand saw, coping saw, 12" hammer, wooden mallet, screw driver, wrenches, cast iron plane, pliers, level, square, etc. Size 16 $\frac{1}{8}$ " x 8" x 3 $\frac{1}{8}$ ". Packed  $\frac{1}{2}$  doz. Shipping wt. 38 lbs. **\$7.00**



**No. M1000—HOUSEHOLD TOOL KIT**

A basic woodworking kit, for ordinary household repairs. Set contains 6 practical tools in handy "picture window" container: Hammer, screw driver, tempered spring steel hand saw with hardwood handle, triangle, wrench, and punch. Illustrations on the use of tools appear on the back of the package. Size: 14" x 8 $\frac{3}{4}$ " x 1 $\frac{1}{4}$ ". Packed 2 doz. to a carton. wt. 21 lbs. **\$1.50**

### BUILT-IN QUALITY FEATURES

Long lasting, beautifully finished hardwood handles provide heft and sturdiness for any job. Cast iron planes. Rugged, durable—unique among junior size tool sets. Fully guaranteed, workable tools. Dad will want to borrow them!

# TOOL CHESTS

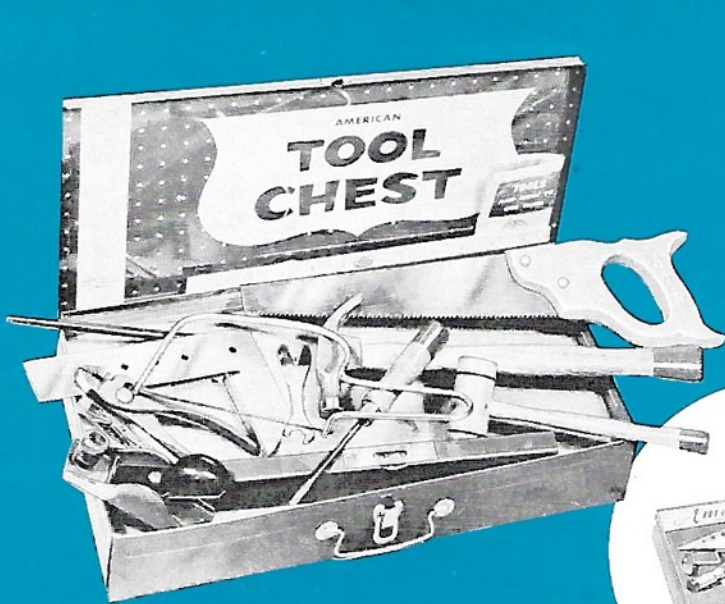

**No. M5—AMERICAN TOOL CHEST—Ages 4-9**

Many's the happy constructive hour your youngster will spend with this deluxe 17-piece tool chest. Packed in a durable carrying case, set includes large tempered spring steel hand saw with beautifully designed handle, 12" hammer, rugged cast iron plane, pliers, level, screw driver, steel square, mallet, etc., plus illustrated project book. Size 16½" long, 8" wide, 3½" high. Packed ½ doz. to carton. Shpg. wt. 31 lbs. **\$5.00**



**No. M5B—AMERICAN TOOL CHEST—Ages 4-9**

His youthful hands will whisk thru countless projects with satisfying ease with this 17-piece woodworking set. Set includes tempered spring steel hand saw with beautifully designed handle, 12" hammer, cast iron plane, brace with assorted bits, screw driver, pliers, triangle, wrench, etc., each trimmed with harmonizing color tone; plus illustrated project book. Size: 16½" long, 8" wide, 3½" high. Packed ½ doz. to carton. Shipping weight, 31 lbs. **\$5.50**



**No. M10—AMERICAN TOOL CHEST—Ages 6-15**

A gigantic 36 piece set equipped with brace and assorted bits, cast iron vise, tempered spring steel hand saw, keyhole saw, coping saw, cast iron plane, 12" hammer, pliers, wrenches, wire stripper, large wooden mallet, screw driver, steel square, etc. Size 18½" x 10½" x 3". Packed 1 to a carton. Shipping weight 9 lbs. **\$10.00**

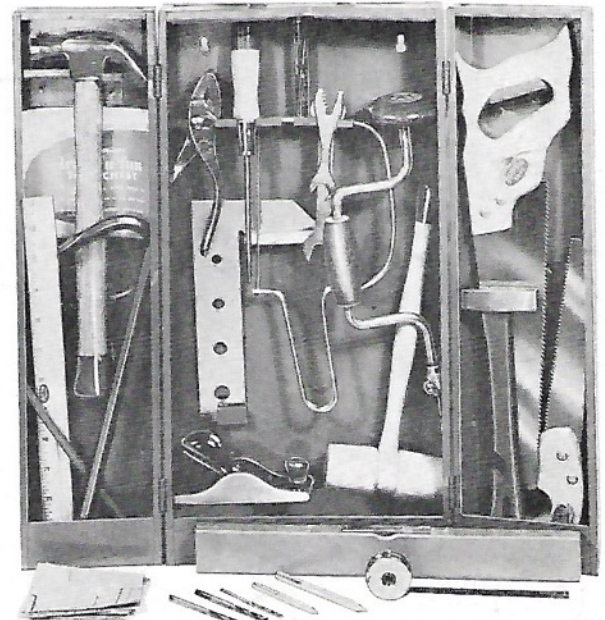

**No. M13—ALL-STEEL TOOL CABINET WITH TOOLS—Ages 6-16**

A dandy 35 piece deluxe set which includes crowbar, wrecking hammer, forged pliers, 12" hammer, 3 saws, brace and drill bits, level, screw driver, tape measure, steel square, mallet, cast iron plane, etc. Cabinet can be hung on wall and is equipped with brackets for holding tools. Size 18¼" x 18" x 2"—open. Packed ½ doz. Shpg. wt. 54 lbs. **\$13.00**

**No. W10—STEEL TOOL CABINET WITH TOOLS (Not Ill.)—Ages 6-16**

A 23 piece set in same cabinet illustrated above includes saw, 12" hammer, brace and bit, plane, steel square, wrenches, pliers, etc. Packed ½ doz.; Shipping weight 50 lbs. **\$10.00**

# for YOUNG "CARPENTERS and MECHANICS"



**No. W510—WORK BENCH WITH TOOLS—Ages 6-16**

This popular work table is built to take punishment. Fully equipped with the tools the junior craftsman needs to follow in

Dad's footsteps. 13-piece tool assortment includes tempered spring steel saw, hammer, pliers, screw driver, triangle, punch, etc. The Bench has tool holders, pegboard back, drawer, built-in measuring scale and sure-grip vise. Illustrated project book is also included. Size 23½" x 16" x 31½" high. Packed 1 each to a carton. Shipping weight 15¼ lbs. **\$10.00**

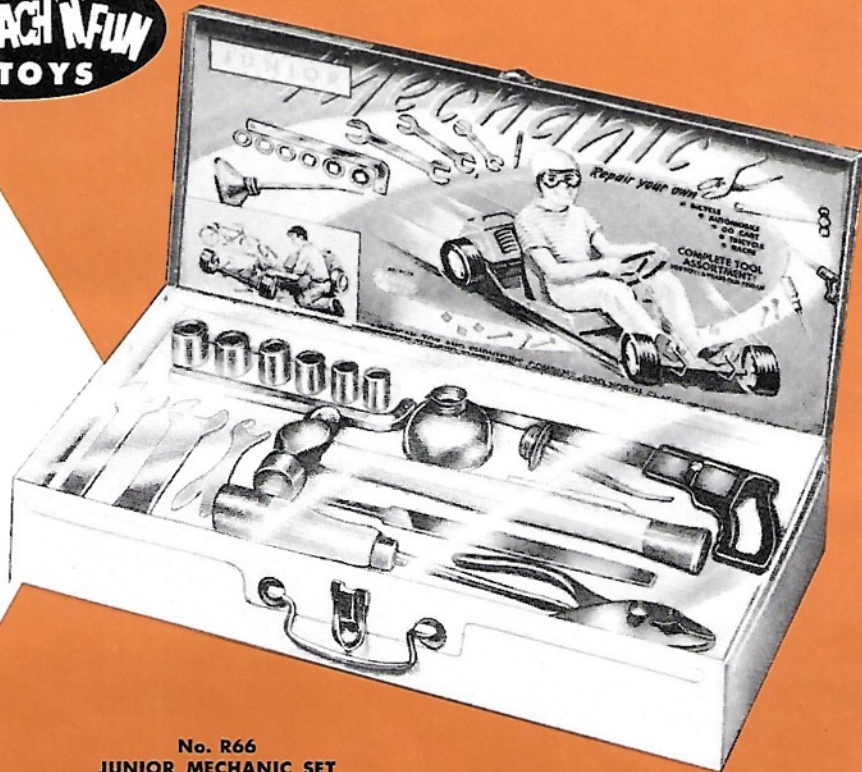

**No. R66 JUNIOR MECHANIC SET Ages 6-16**

Now your youngster can repair his own bicycle, go-cart,

automobile, tricycle or race car. He'll really prize this fascinating kit and become the "mechanic" around the house. Kit includes 7-piece socket set, metal cutting saw, forged pliers, Ballpeen hammer, metal file, open end wrenches, oil can, screw driver and punch, etc. Set furnished in beautiful full-color Litho steel case with metal carrying handle. Packed ½ doz.; Shpg. wt. 25 lbs. **\$6.00**  
\*Tools are "Skin Packaged."



**No. W8—CARPENTER TOOL BOX WITH TOOLS—Ages 6-15**

A junior size copy of a real carpenter's tote box. It's a handy wooden tool box with sliding cover. This 24-piece set includes brace and bit, tempered spring steel saw, coping saw, 12" hammer, cast-iron plane, two wrenches, screw driver, etc. The case is beautifully finished in bright red. Size: 19½" long, 7¾" wide, 8" high. Packed 1 each to a carton. Shipping weight 9 lbs. **\$8.00**

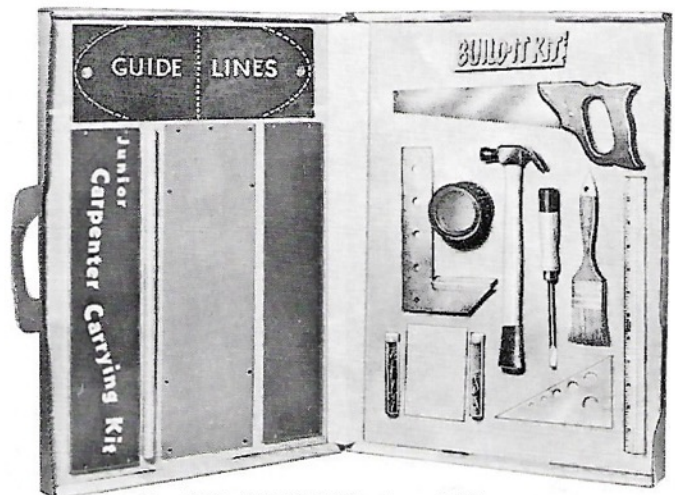

**No. 219—BUILD-IT-KIT—Ages 6-16**

A new concept in tool kits for boys. Tools plus materials! All the tools and equipment a young woodworker needs to make his own Carpenter's Tote kit. And a big bonus! He gets a generous supply of bright red lacquer paint and a special paint brush to finish his useful carrying case. Tools included in the set are: Tempered Steel Saw, Coping Saw, Ruler, Hammer, Steel Square, Screw Driver, Paint Brush with paint, Nails, Screws, Manual and Sandpaper. Materials included: Quarter-inch lumber—2 side panels 14½" x 3¼"; one piece 12" x 4" to make end pieces; one piece hardboard 14¾" x 4¾".



**NEW**

Attractively packaged in book-form case. Tools and materials are skin-packed. Size: 20¼" x 14¾" x 4¼" (Closed). Master pack, 6 to carton. Shipping wt., 27 lbs. **\$6.00**

# NEW



## The Town of Fun!

- ★ WOODBURNING
- ★ RUBBER MOLDING
- ★ METAL TAPPING
- ★ SPARKLE & PAINT CRAFT



### No. 98—HOBBYLAND U.S.A.—The Town of Fun—Ages 6-16 and up

Here's a houseful of fun in one big package. Activities for hobby lovers of all ages. Approximately 100 pieces in this set. Hobbies including Rubber Molding, Wonder Pen Woodburning, Monogramming, Sparkle Craft Art, Stereo Metal Tapping. Projects galore—book-ends, tie-racks, personalized stationery, wall plaques, etc. HOBBYLAND, U.S.A. comes in a deluxe colorful book-form box—all skin-packed for item protection. This is a sure-fire hit for kids that love to do things creatively. Size of individual box 20 1/4" x 14 3/4" x 4 1/4". Packed 6 to a carton. Weight 28 lbs. per carton. **\$10.00**



### No. R5—RUBBER MOLDING SET—Ages 5-13 and up

Just like magic—boys and girls can create their own useful rubber objects from the special B. F. Goodrich liquid Latex rubber designed specifically for this item. Boys can make lifelike fishing lures. Girls can make stickpins, earrings, coasters, etc. Easy to do! Liquid rubber is poured into plastic molds and allowed to cure. The finished object is removed from the mold in a solid state. Its amazing. No heat is required. All molds can be used and reused hundreds of times. Set contains 4 tubes and 2 squeeze bottles containing special liquid rubber in 6 breathtaking colors; 6 reusable plastic molds, special applicator rod, findings for earrings and stickpins, fish hooks. Complete, easy to follow instructions. Packed 1 doz. to carton. Shpg. wt. 24 lbs. **\$4.00**

### No. 3000 STEREO-METAL TAPPING SET Ages 4-10

The time-honored art of metal tapping brought up-to-date. Contains 2 pre-cut projects (tie rack and book ends) plus interesting framed subject. Kit includes 6 wood-mounted metal plaques, tapping hammer and ball-grip handle, 2 punches (hole punch and chisel punch), and mounting nails, plus illustrated booklet on metal tapping. Packed 1 doz. to a carton. Shpg. wt. 32 lbs. **\$3.00**

### No. 14—4-IN-1 COMBINATION

Everyone will have fun with this 4 in 1 combination set, because it's actually 4 art techniques in one set! Included are: Stereo-metal tapping with "ready-to-assemble" projects; woodburning on plywood plaques, color painting and monogramming. With the kit, you get a 5-year guaranteed U.L. approved Wonder Pen with extra point, 8 woodburning plaques, 4 pieces for metal tapping, special TEACH-N-FUN (12 piece) monogramming set, paint chips, nails, brush, ball-grip tapping hammer with two special punches, foil and paper. Complete instructions included. Packed 1/2 doz. to a carton. Shipping weight, 17 1/4 lbs. **\$5.00**



### No. 52—DELUXE SPARKLE CRAFT—NEWLY REPACKAGED Ages 4-12

Paintings take on dazzling, new beauty when decorated with sparkle. Here is a craft set that enables boys and girls to produce brilliantly finished paintings trimmed with sparkle. And mothers can relax. No messy glue is needed. All the child does is add water to the tinted portions of the specially treated plaques. (This process is PATENT PENDING.) Then he adds sparkle and completes the picture with the paint chips provided. Seven special plaques in all. 10 envelopes with sparkle (in 5 colors—silver, green, blue, gold and red); plastic dispenser tube with additional sparkle, paint palette with color chips, brush, illustrated instruction sheet. Packed 1 doz.; wt. 16 lbs. **\$2.00**



# EXCITINGLY NEW

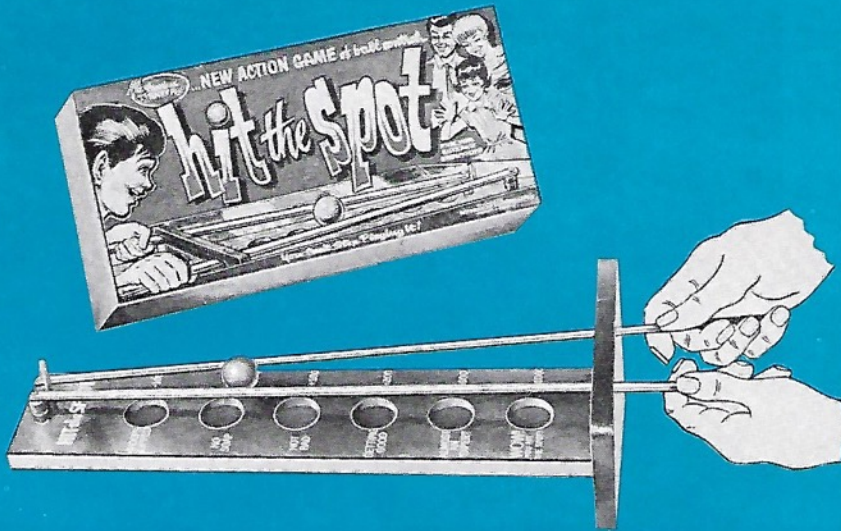

### No. 24—HIT-THE-SPOT—Ages 6-Adult

An excellent action game for youngsters and grown-ups too! Once you start playing HIT THE SPOT, you can't stop! The idea is to propel the ball upwards by manipulating the steel rods. Then try to drop the ball into the cup with the highest score. Easy to follow rules are printed directly on package insert with description of different ways to play "HIT-THE-SPOT." Sturdy wood construction with beautiful maple finish. Attractively packaged in full-color Litho display box. Size 21" x 10 1/4" x 4". Packed 1/2 doz. to master carton. Shipping weight, 26 1/2 lbs. **\$4.00**

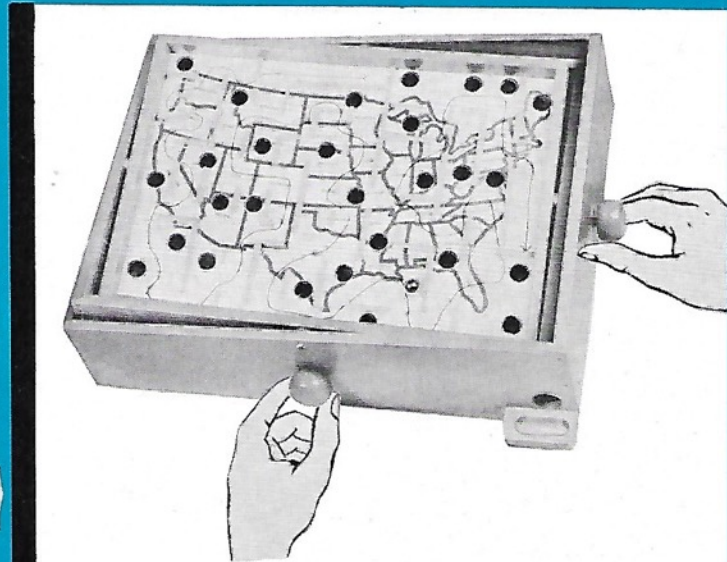

### No. 220—COAST-TO-COAST—Ages 6-Adult

The action game where you try to get the steel ball from "Coast-to-Coast" without allowing the ball to drop into any of the holes along the way. Movement of the ball is controlled by tilting the board up and down or sideways, using the two twist-em dials. You move ball from state to state by following path indicated on the printed map. It's educational as well as loads of fun. Like fine furniture, COAST-TO-COAST is of sturdy wood construction with beautiful maple finish. Size: 14 1/2" x 11" x 3 1/2". Attractively packed in display box, 6 to carton. Shipping weight, 20 lbs. **\$6.00**

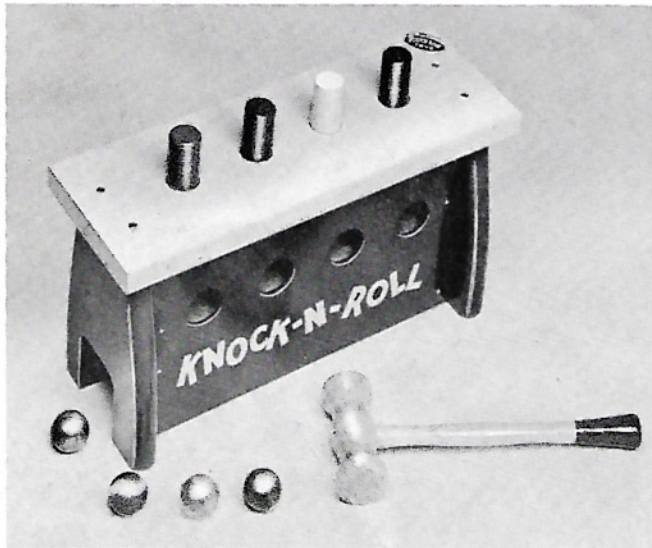

### No. B31—KNOCK'N ROLL—Ages 18 mos. to 5 years

A modern action toy to fascinate the pre-schooler. Knock the colored peg—and like magic—out rolls a big marble of the same color; four pegs—four marbles. It's educational, too—youngsters learn to match each marble with the peg of the same color. Packaged in a beautiful display carton for maximum appeal at point of sale. Patent pending on this unique pre-school toy. Size: 10 1/2" long x 7 1/2" high x 4" wide. One dozen to carton. Shipping wt., 33 lbs. **\$3.00**

## New Design!

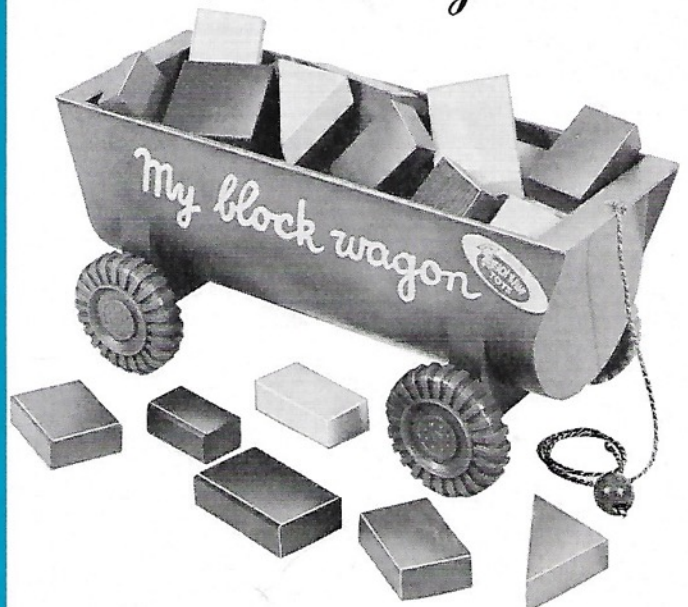

### No. B916—MY BLOCK WAGON—Ages 2-6

A blockbuster of a block wagon. Brightly finished wood blocks in every possible shape, color and size. Deep pull toy wagon holds all the blocks and transports them to the "building site." Finest plastic construction for utmost durability. Red body and blue wheels. Size 12" long, 6 1/2" wide, 5 1/2" high. Packed 1 doz. Shipping weight, 30 lbs. **\$2.00**



# FOR 1962

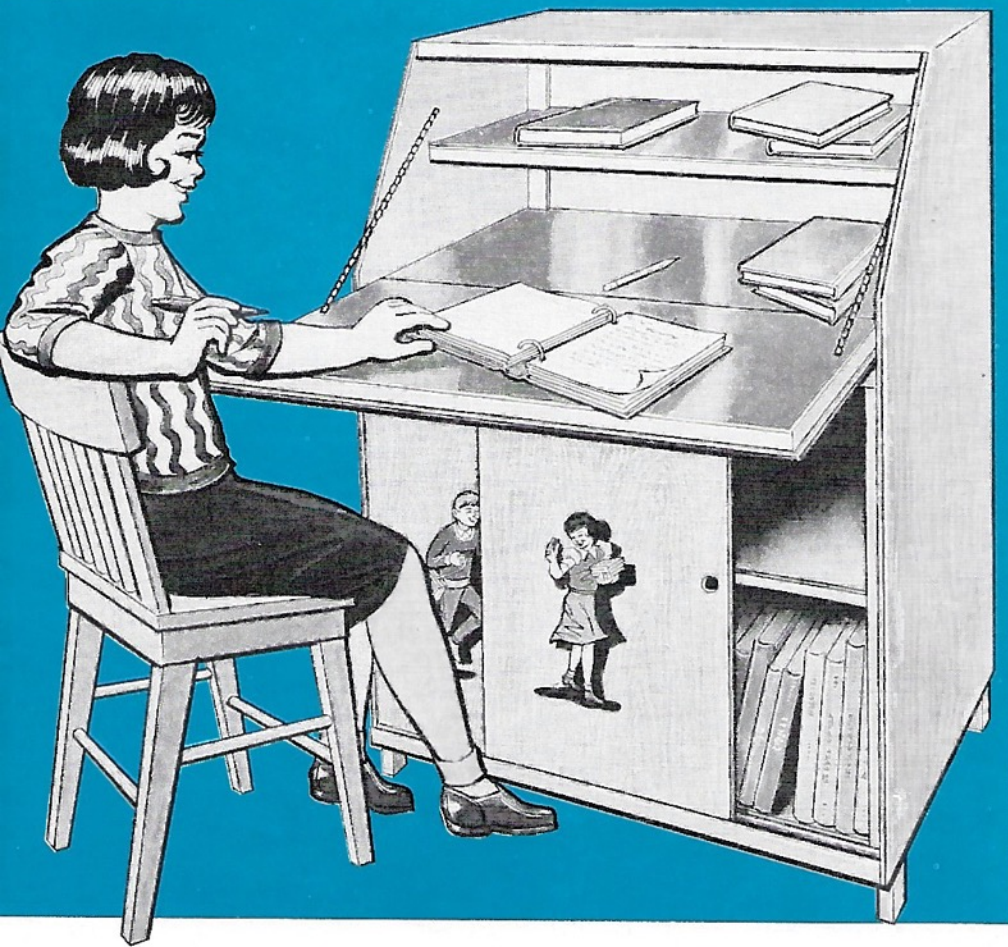

## No. 213—WRITING DESK & CABINET—Ages 6-16

Here's a new outstanding A.T.F. product combining utility, style, beauty and modest price. Every school-aged child will be proud to own his own writing desk cabinet. Look at all the features! Plenty of storage room above and below for books, school papers, toys, even clothing. Top swings down for use as writing desk. When top is closed it is used as convenient appointment and date record. Kids can remember all the important "things to do this week" with this date guide. Writing desk is constructed of unique wood grained hardboard with attractive modern "school-time" screening on the sliding doors. Over-all height is 36", width 24", depth 16"; desk surface area (opened) is 27" deep by 23½" wide. Packed one to a carton, K.D. Weight 26 lbs. **\$13.00**

## For Tomorrow's Scientists

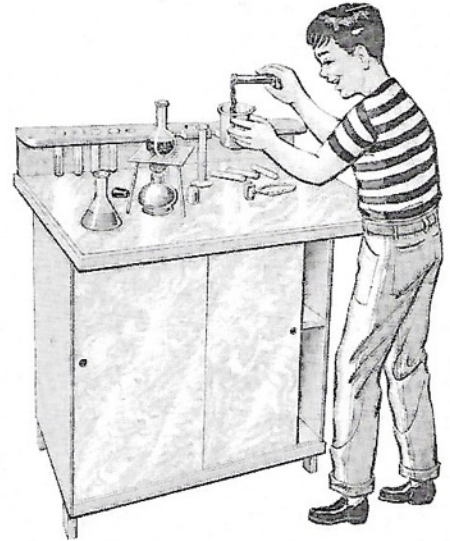

**No. 216—SCIENCE LAB TABLE—Ages 6-16 and up**  
At last! A genuine scientific work table for all "young scientists." Solidly built, constructed of brilliant NON-STAIN, liquid resistant MIRA-TILE. Overall table size is 30½" high, 24½" wide, 16½" deep. Room to store all the equipment, lab materials, scientific manuals our junior scientist possesses. Spacious storage area, with a shelf divider, measures 23" high, 23" wide, 11" deep. Packed 1 each in a box, K.D. Weight 20 lbs. **Table only \$11.00**

## No. 217—SCIENTIFIC LAB EQUIPMENT (as illustrated above)

Genuine Pyrex Scientific Glassware plus other accessories needed for basic research and experimentation. Includes: 8 Test Tubes, graduated cylinder, test tube holder, glass beaker, alcohol lamp (2-piece), heating stand, asbestos support, Boiling Flask and Erlenmeyer Flask and rubber stopper. All glassware made of heat-proof PYREX—the finest in scientific glassware.

Accessories only **\$6.00**

## WESTERN GUN RACK and OUTDOORSMAN FISHING RACK

### No. G1—WESTERN GUN RACK

Designed to appeal to every young outdoorsman, this handsome Gun Rack is equipped to handle any young "hunter's" prized equipment: rifles, gunbelts, pistols, etc. Attractively finished in maple with action screening. Size: 20" long, 13" high, 4" deep, complete with 9 hanger pegs. Packed K.D., 1 doz. per carton, Wt. 13 lbs. **\$1.00**

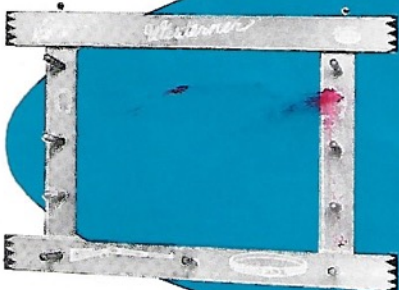

### No. F1—OUTDOORSMAN FISHING RACK

An entirely new concept: A place for every young fisherman to store all his fishing gear. Urethane attachments for flies and lures and metal pegs for rods and reels. Beautifully finished in maple with action screening. Size: 22" long, 11½" high, 3" deep. Packed K.D., 1 doz. to carton. Weight 13 lbs. **\$1.00**



# COMPLETE LINE OF QUALITY DESK SETS



**No. B6—COMBINATION  
BLACKBOARD AND PEG  
TABLE—Ages 2-10**

One of the most popular of all educational toys! A two-in-one delight. It's a chalkboard—with clear, easy-to-follow numbers, alphabet, chalk and eraser. It's also a peg board—with mallet and colorful pegs. Solid rugged wood construction. Beautifully finished in maple, this item is an attractive piece of furniture. Green chalkboard is hinged and set at convenient writing angle. Unit measures: 21½" x 19" x 25" deep. Desk size 12" x 19". Packed one each to a carton. Ship. wt. 8½ lbs. **\$6.00**



**No. B5—TUBULAR PEG DESK-COMBINATION BLACKBOARD  
AND PEG TABLE—Ages 2-10**

A sensational value. All the play features of the standard peg tables at the lowest possible price. Brightly designed numerals and letters on pleasing green writing area. Slide-off top reveals a peg board on the inside. Chalk, eraser, mallet and pegs are included. Legs and support come in lightweight, bright aluminum tubing. Takes lots of wear and tear... always looks smart and stylish! Unit measures 25" deep, 21" high, 18" wide. Desk size: 18" x 11½". Packed 1 each; Shipping wt. 6 lbs. **\$5.00**



**No. B8—TWIN TUBULAR PEG DESK—Ages 2-10**

A double delight! Plenty of room for two youngsters to learn and play together. There's two of everything! Green chalkboards with easy-to-read numbers and letters, chalk and erasers. Youngsters can even eat their lunch right at their very own play table. Slide-off the tops, to find double-sized peg board inside! Complete with 2 mallets and 2 sets of pegs for design fun. Compact and steady with reinforced support. Easy to store, too, with collapsible legs that fold under in a jiffy! Smartly styled aluminum tubing construction. Unit measures (open) 47" wide by 20" high. Desk surfaces (each) 18" x 9". Packed 1 each; shipping wt. 9½ lbs. **\$8.00**

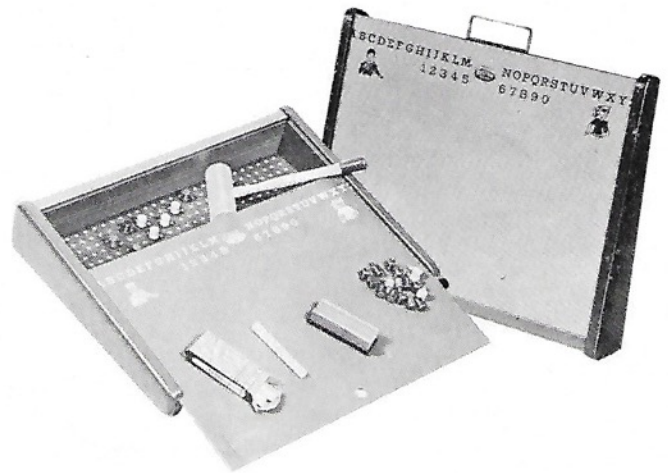

**No. B603—PORTABLE PEG DESK—Ages 3-6**

For the youngster on the go! All play tools are stored within. Excellent for lap or bed use. Contains green chalkboard with chalk, eraser, peg board, mallet and colorful pegs. Brilliant Multi-color finish with polished brass carrying handle. Packed 1 doz. to a carton. Shipping wt. 44 lbs. **\$3.00**



# TOY CHESTS

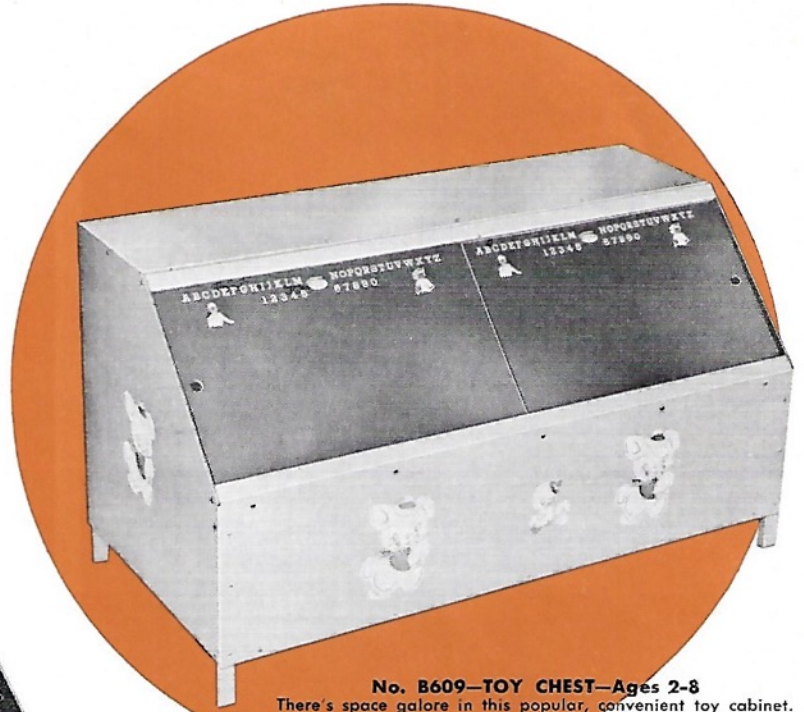
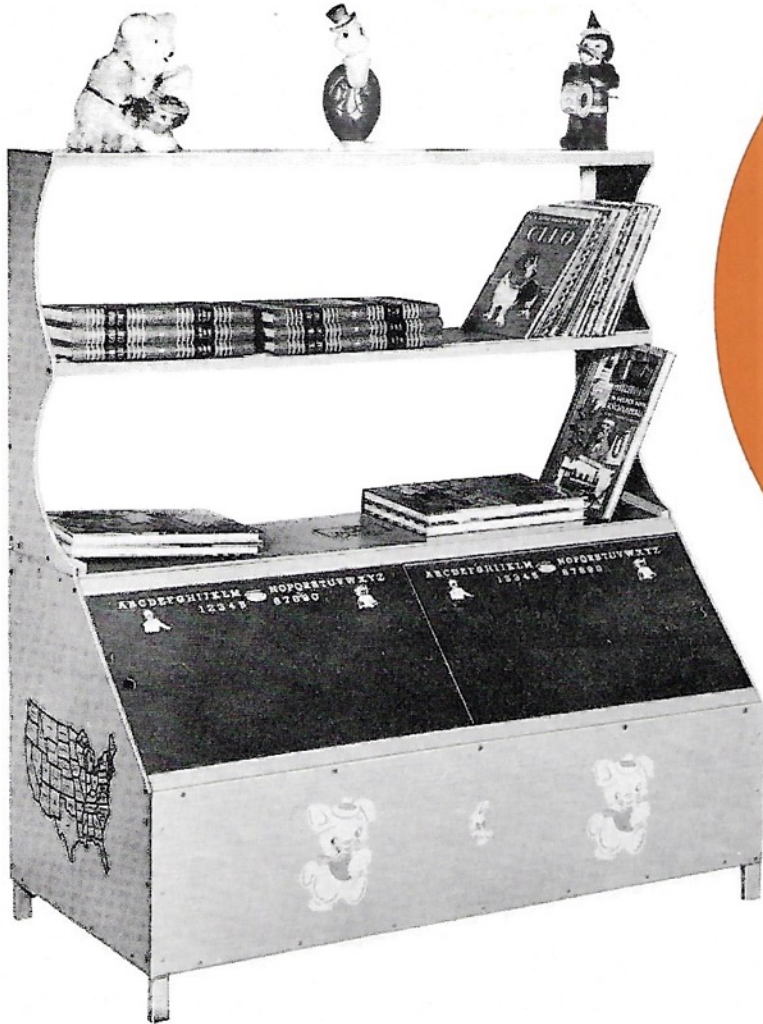

**No. B609—TOY CHEST—Ages 2-8**

There's space galore in this popular, convenient toy cabinet. Beautiful wood-grain finish makes it a most attractive article of furniture. Gaily decorated with play figures—also includes maps of the United States on side panels. Sliding doors are green chalkboard for added play value. This sturdily built chest will compliment any room in the house. Size: 36" x 17½" x 20" high. Packed 1 to a carton. Ship. wt. 20½ lbs. **\$9.00**

**No. B613—TOY CHEST WITH BOOK SHELVES**

**Ages 2-8**

A tasteful addition to the home. Cabinet has distinctive wood-grain finish giving it the appearance of costly furniture. Decorated with colorful figures on front with maps of the United States on the sides. Plenty of extra space for books and knicknacks on the 3 convenient shelves. Bottom shelf holds 10" books standing upright. Size: 36" wide x 17½" deep x 41" high. Packed 1 to a carton. Shipping weight, 25 lbs. **\$13.00**



**No. 211—PIRATE TOY CHEST—Ages 5-12**

Ship Ahoy! Here's a real boy's toy chest designed exactly like the treasure chests of old. Constructed of wood-grained hardboard, with two-color screened pictures of Pirate ship, Pirates finding buried treasure, etc. Chest contains authentic-looking lock and latch. Roomy, this chest holds a treasure-trove of toys! Size set-up: 30" long x 17" wide x 15" deep. Shipped K.D., 1 each in a box. Weight 15¾ lbs. **\$11.00**



**No. 210—TOY CHEST (BASKET-WEAVE STYLE)—Ages 2-8**

A large, roomy new chest designed to hold all of junior's playthings. Over-all size is 31½" x 16" x 15" high with large storage area. This item is sturdy—can support the weight of two youngsters sitting on the closed top. Distinctive Buff Finish. Teach 'N Fun chest is constructed of a unique interwoven hardboard which produces a BASKET WEAVE EFFECT. Mothers and kids both love it! Attractive, large decals on top. Packed one to a carton, K.D., Weight, 16½ lbs. **\$10.00**



# DOLL BEDS

**NEW**

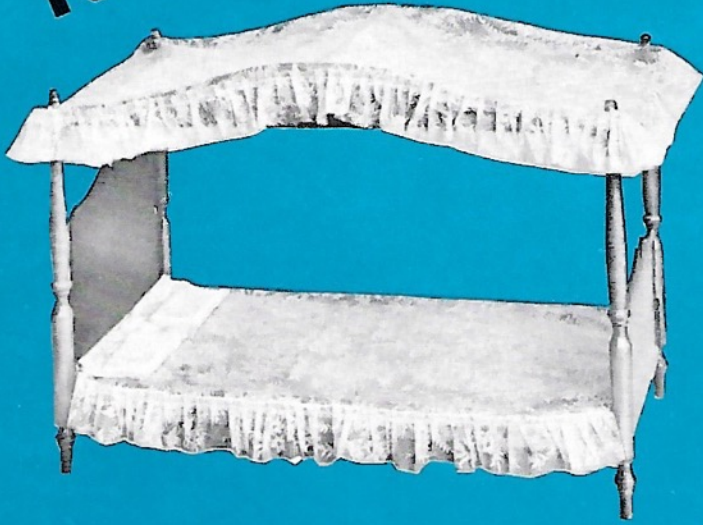

**No. C8—CANOPY DOLL BED**  
(Size: 26" long, 19" high, 15" wide)

Authentically styled replica of the Colonial Four-Poster, made of solid hardwood with pink lacy spread over a fluffy mattress and a lacy canopy top. Stunningly finished in maple—a gift that any girl will cherish through the years. In individual display carton; ½ doz. to shipping carton; weight 45 lbs. **\$8.00**

**No. C3—CANOPY DOLL BED**  
(Size: 13" long x 12" high x 6¼" wide)

As pictured above, sized specifically for "teen-aged fashion" dolls now in great demand. Individual carton: 1 doz. to shipper; wt. 30 lbs. **\$3.00**

**\$4.00**

**NEW**

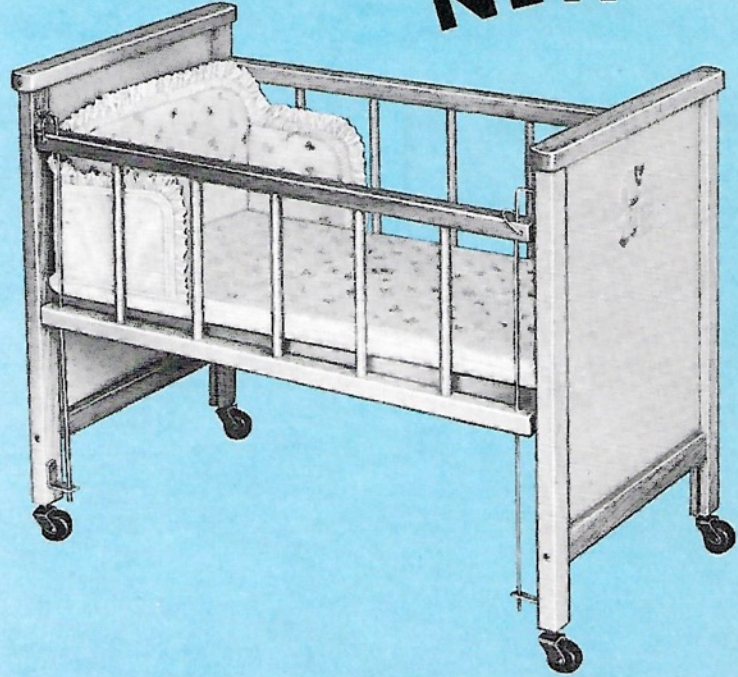

**No. B700—DELUXE DROP-SIDE CRIB—Ages 2-10**

Her lucky "baby" will sleep in real luxury when nestled in this extra-sturdy doll crib. Solid hardwood construction; with beautiful clear-finish to show wood grain. Panels are soft pink with colorful decals. Mattress and head bumper for dolly's "comfort." Has dropside as well as casters for utmost utility. Size is 24" x 14" width by 19" high. Packed 1 to a carton. KD. Weight 8½ lbs. **\$7.00**



**No. B-600—MAPLE CRIB WITH DROPSIDE—Ages 2-10**

It's off to dreamland for her "baby" in this full panel, drop-side crib. Trouble-free, the dropside operates simply with a flip of the metal ring. Crib is equipped with regular stem-type swivel casters, which permit easy movement. Finished in maple and tastefully decorated with delightful storybook characters. Size 26" long, 15" wide, 19" high. Packed 1 each to a carton. Shipping weight 7 lbs. **\$6.00**

**No. B910—CANDY STRIPED DOLL CRIB—Ages 2-10**

Same construction as Crib illustrated above except finish is colorful candy stripe. (Companion piece to the Candy Stripe Toy Pen and Cradle.) Packed 1 each. Shipping weight 7 lbs. **\$6.00**

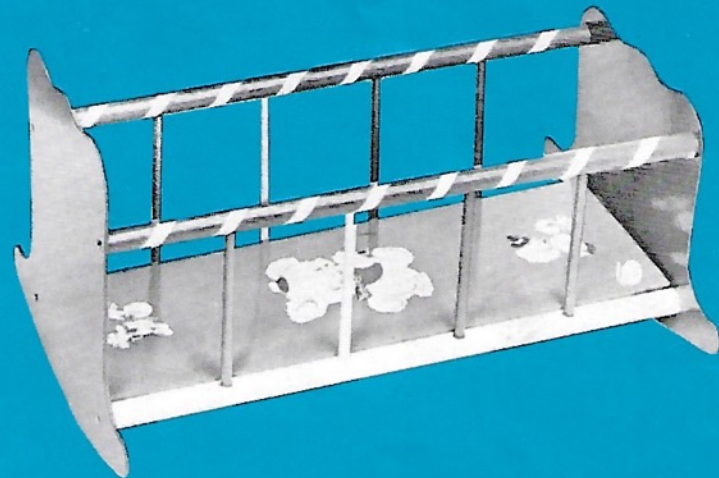

**No. B912—CANDY STRIPED CRADLE—Ages 2-10**

She'll sing, "Rock-a-bye baby," when she puts her favorite dolls to sleep in this brightly colored doll cradle. A beautiful addition to any doll's bedroom. Big enough to hold standard size dolls up to 20" long. Has remarkable peppermint stripe finish. (A companion piece to the Crib and Toy Pen.) Size: 21" long, 14" wide, 11" high. Packed ½ doz. each in carton. Shipping weight 22 lbs. **\$3.00**

**No. B602—MAPLE CRADLE—Ages 2-10**

Same construction as Cradle illustrated above except finished in handsome Maple. (Companion piece to Maple Crib and Toy Pen.) Packed ½ doz. Shipping weight 22 lbs. **\$3.00**

# WALL BOARDS and TOY FURNITURE

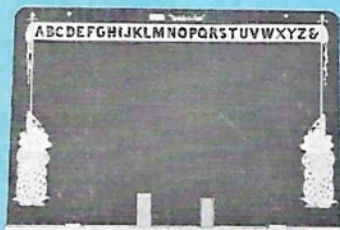

**No. B11—WALL BLACKBOARD**  
Ages 3-8

Drawing and writing are lots of fun on this colorful wall blackboard. Smooth, clear surface wipes clean with a damp cloth. Has handy wood rail for holding chalk and eraser which are provided. Size 18" x 36". Packed 4 each to a carton. Shipping wt. 16½ lbs. **\$2.00**



**No. B13—GREEN CHALKBOARD**  
Ages 5-9

Easy to write on . . . easy to read from! This pleasing eye-relaxing, green chalkboard has alphabet and numerals to make it easy for the child to follow. Composition surface is bordered with wood frame. Complete with chalk, eraser and wood rail. Size: 25" x 19". Packed 4 ea. to a carton. Shipping wt. 26 lbs. **\$3.00**

**No. B64—CHAIR STEP COMBINATION—Ages 18 mo. to 5 years**

TV watching's lots more fun on this combination all-wood step stool and chair. Simple flip of the back-rest transforms chair into a step stool with two safe child-spaced steps. It's a rugged yet light weight unit, finished in beautiful maple. Size: 11" x 12½" x 14" chair; 12½" x 15" high step. Packed 1 per carton. Shipping wt. 4 lbs. **\$4.00**



**No. B911—CANDY STRIPED MOBILE TOY PEN—Ages 2-10**

No more toys scattered all about the room! This deep and spacious Toy Pen will conveniently hold everything junior plays with thruout the day. Sturdily constructed with special swivel pull handle and bright large wheels, it will be your child's constant companion. Toy Pen is gaily colored in unique candy stripe finish, complete with story book pictures. (A companion piece to the Cradle and Crib.) Size: 36" over-all length, 16" wide, 14" high. Packed 1 each to a carton. Shipping weight 5 lbs. **\$5.00**

**No. B601—MAPLE TOY PEN**

Same construction as Toy Pen illustrated, except finish is in rich Maple. (Companion piece to Maple Crib and Cradle.) Packed 1 each. Shipping weight. 5 lbs. **\$5.00**

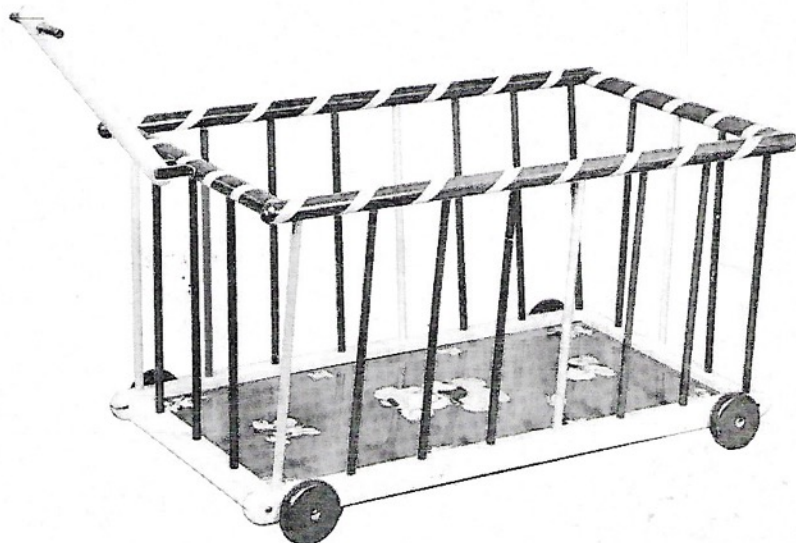

**No. 142—MAPLE DOLL HIGH CHAIR—Ages 2-10**

A high chair for her doll—to make your little girl feel really "grown-up!" Chair is equipped with drop-leaf feeding tray, comfy foot rest and colorful decal on the chair-back.

Non-toxic furniture finish. Size: 29" high, 13" wide. Packed in individual carton. Wt. 5 lbs. **\$4.00**

**No. 140—DOLL HIGH CHAIR—Ages 2-10**

Mealtimes are lots of fun when your little girl can feed her own "baby" in this all-steel high chair. It's an exact replica of "baby brother's" chair, from its movable formed steel tray with colored beads right down to its sturdily braced legs that prevent tipping. Colorful decals add a finished note. Size: 30" high, 12" wide. Packed ½ doz. to a carton. Shipping weight, 30½ lbs. **\$4.00**



# PRE-SCHOOL TOYS



**No. B30—PLAYBENCH WITH CLOCK**  
Ages 2-6

This fascinating playbench keeps the pre-school set occupied—they take it apart, put it back together again. They can learn to tell time too as they move the large clock hands. Every piece finished in non-toxic colors and made of smoothly rounded wood. Includes vise, wrench, mallet, screwdriver, nuts and wooden screws. Everything comes apart... even the bench for re-assembly. Size: 11½" x 5½" x 6½". Packed ½ doz. to a carton. Shipping wt. 15 lbs. **\$3.00**

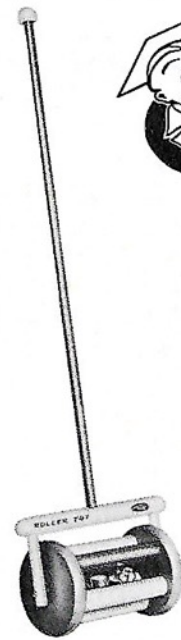

**No. B125—ROLLER TOT**  
PUSH TOY

Ages 15 mos. to 3 yrs.

Young, unsteady legs stay perfectly balanced indoors and out! A smoothly operating unit with colorful pegs that tumble and bells that jingle gaily as the youngster pushes the Roller-Tot along. Size: 29" long x 8¾" wide. Packed 1 doz. to carton. 13 lbs. **\$1.50**

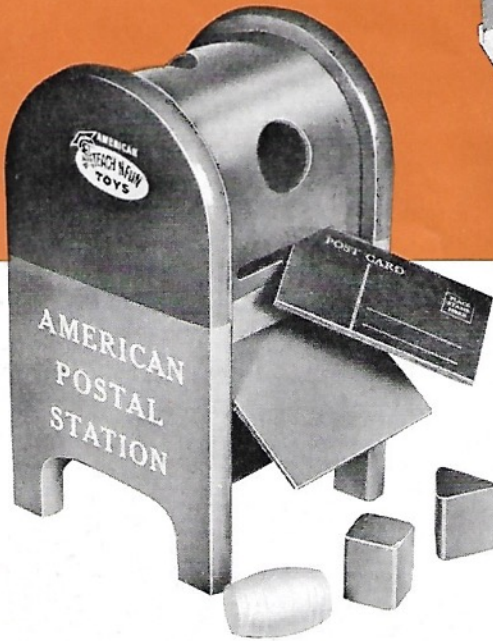
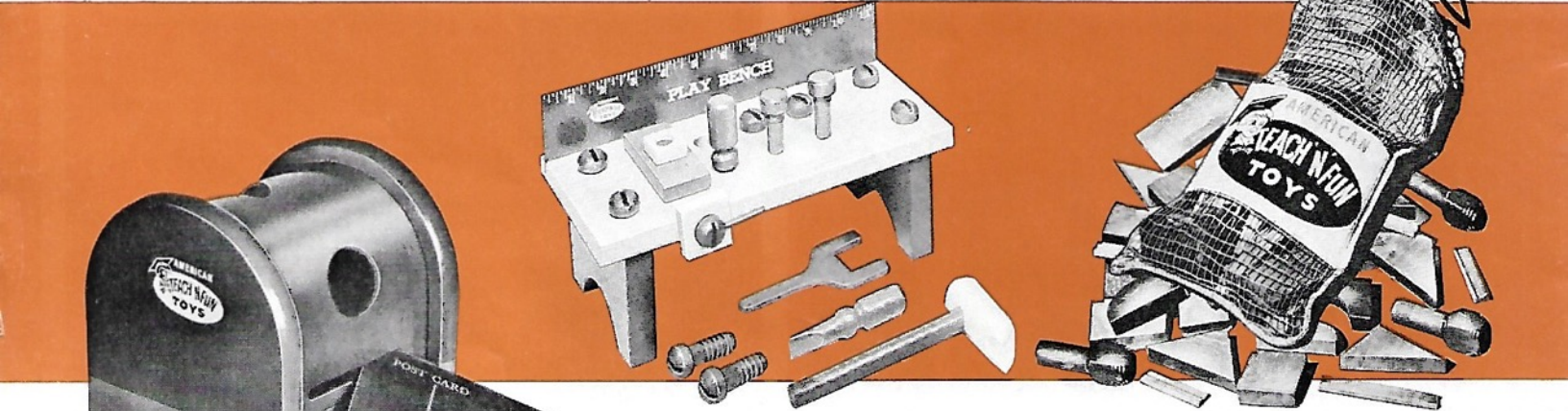

**No. B57—AMERICAN POSTAL STATION—Ages 1-4**

An exact replica of a genuine red, white and blue U.S. Postal Station. Has assorted shaped blocks and make-believe "post card" which fit into corresponding holes. Aids in development of finger dexterity, shape discrimination and eye-hand coordination. Colored blocks tumble out of easily operated trap door. Size: 10¾" x 5¾" x 6". Packed ½ doz.; wt. 16 lbs. **\$3.00**

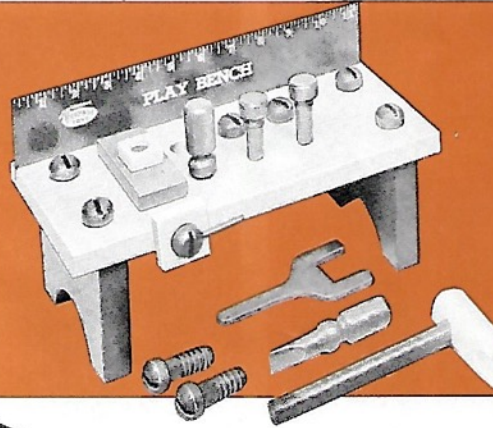

**No. B25—A.T.F. PLAY BENCH**  
Ages 2-6

An all-time favorite among pre-school toys. Youngsters happily receive training in the use of basic tools. Colorful bench and accessories are made of smoothly finished wood. Endless fun for boys and girls as they learn to hammer, drive wood screws, and use a wrench with the safe wood "tools" provided. The entire bench completely comes apart and is easily put together again. Size: 11½" x 5½" x 6½". Packed 1 doz. to a carton. Shipping wt. 27 lbs. **\$2.50**



**No. B58—BLOCK ASSORTMENT**  
Ages 2-5

Wood blocks galore! In every conceivable size, shape and color! Includes squares, oblongs, triangles and pegs. Watch castles, barns and buildings rise through creative imagination. Safe, non-toxic paints. Packed 1 doz. to shipping carton. Weight 32 lbs. **\$1.50**

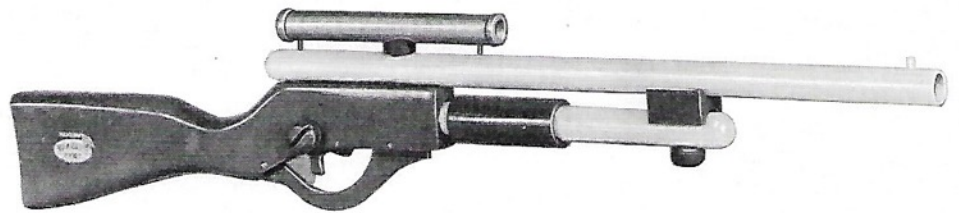

**No. B-94—BIG GAME RIFLE—Ages 2-8**

An exciting replica of a real hunter's rifle! He's able to take the rifle apart just like real hunters do. All wood construction, finished in bright eye-pleasing colors and packed in attractive window display box. Size: 27" long. Packed 1 doz. to a carton. Shipping weight, 14 lbs. **\$3.00**

# POUNDING TOYS

**NOTE:** A pounding board is a basic developmental toy. During their first years children enjoy the "feel" of testing their strength, witnessing their ability to drive pegs into the board and hearing sounds made through their efforts.

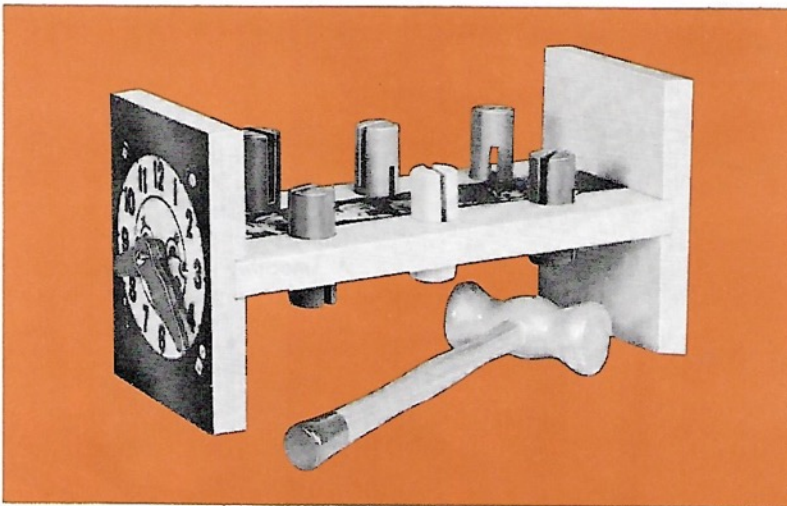

**No. B100—POUNDING BOARD WITH CLOCK**  
Ages 1-4

A wonderful educational toy from every standpoint—attractiveness, play features and value! Includes six colored jumbo pegs. Has a clock face with movable hands—a wonderful aid in teaching youngsters to tell time. After pegs are pounded on one side, toy may be reversed for pounding on other side. Keeps tots busy and happy for hours. Size 10" x 5" x 4". Packed 2 dozen to carton; shipping weight 29 lbs. **\$1.00**

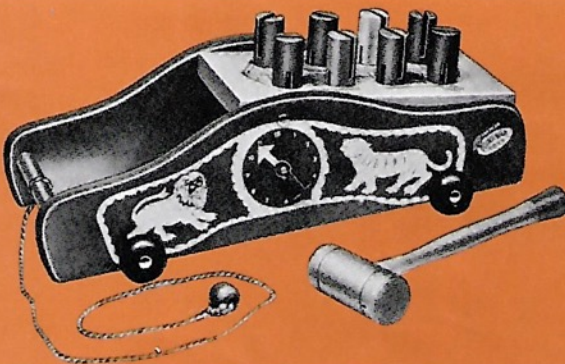

**No. B63—FLIP FLOP CIRCUS CART—Ages 1-5**  
Here's a combination pull toy and reversible peg pounder. Colorful, sturdy all-wood construction with gay animated cartoons on both sides. 8 colorful jumbo pegs may be pounded from either side of platform which flips on center hinge. Make-believe clock on both sides, with movable hands. Wood mallet included. Size: 13½" x 7¼" x 4½". Packed 1 dozen to shipping carton; wt. 26½ lbs. **\$3.00**

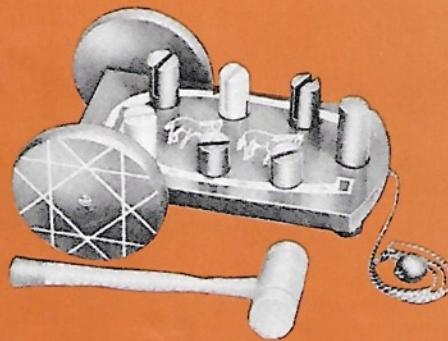

**No. B85—POUNDING BOARD PULL TOY**  
Ages 1-3  
A twin-purpose toy that's a reversible cart. Durable constructed, brilliant red finish, this cart includes 6 colorful slotted jumbo pegs and wood mallet. One fixed peg balances toy for reversible pounding action. Size: 9¼" x 6" x 4½". Packed 1 dozen to carton; shipping weight 15 lbs. **\$1.50**

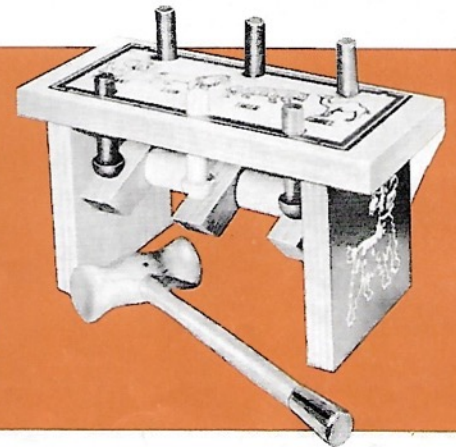

**No. B918—POP-UP POUNDING BOARD**  
Ages 8 mo.-3 yrs.  
When one peg is pounded down, another peg comes up automatically. Particularly suited to the very young child, since pegs pop up and down with a very light touch. Attractive design is printed on side panel. Size: 9" x 6" x 4". Packed 2 dozen to carton; shipping weight 28 lbs. **\$1.50**

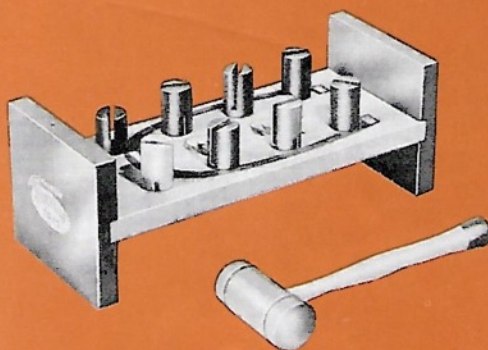

**No. B150—DELUXE POUNDING BOARD**  
Ages 1-5

A stream-lined beautifully finished reversible board with 8 brightly colored jumbo pegs which can be driven in from either side. Size: 10¾" x 4½" x 4". Packed 1 doz. to a ctn. Shipping wt. 17 lbs. **\$1.50**

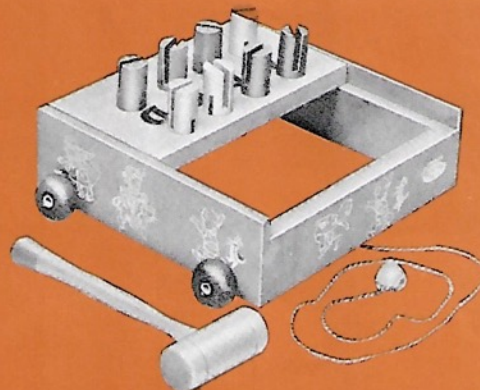

**No. B145—FLIP-FLOP POUNDING CART**  
Ages 1-5

Pound on one side—flip it over and pound again! Colorful pull string and wheels. Colorfully painted in non-toxic red finish, trimmed with animated cartoons. 8 bright jumbo pegs rest on hinged, reversible panel. Size: 10¾" x 4½" x 4". Packed 1 dozen to a carton; shipping weight 21 lbs. **\$2.00**

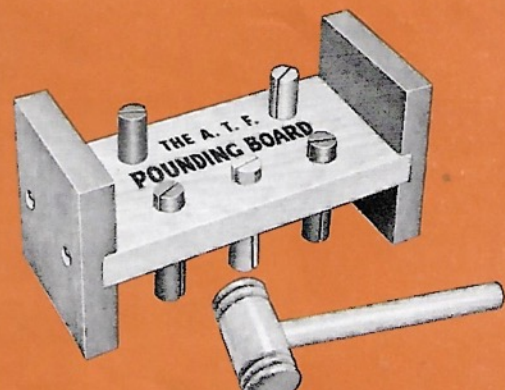

**No. B60—A.T.F. POUNDING BOARD**  
Ages 1-4

Most inexpensive peg pounder on the market. Includes 5 jumbo rainbow-colored pegs which may be driven in from either side. Mallet also included in this unusual value. Size: 8" x 3¾" x 3¼". Packed 2 dozen to a carton; shipping weight 20 lbs. **\$.69**

**No. B60—A.T.F. POUNDING BOARD—Ages 1-4**



# 1962 TOY AND HOBBY LINE

AMERICAN TOY & FURNITURE CO. Inc.  
6130 N. Clark St. Chicago 26, Ill.

